

Kit 3017

- CITROËN C5**, 4-dr Sedan, 08–
- CITROËN C6**, 5-dr Hatchback, 05–
- PEUGEOT 207**, 3-dr Hatchback, 06–
- PEUGEOT 207**, 5-dr Hatchback, 06–
- PEUGEOT 308**, 3-dr Hatchback, 07–
- PEUGEOT 308**, 5-dr Hatchback, 07–
- PEUGEOT 407**, 4-dr Sedan, 04-10
- PEUGEOT 3008**, 5-dr SUV, 09–
- PEUGEOT 5008**, 5-dr MPV, 09– (Without integrated railing)

This Kit is only for vehicles with fixpoint mounting.



**460R
753**

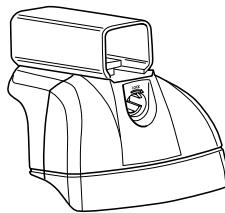

460



- Part 05 / 09 x 2
- Part 04 x 2
- Part 50616 x 4
- Part 05 / 10 x 2
- Part 03 x 2
- Part 50751 x 4
- Part (Directional Sign) x 1

Kit



753

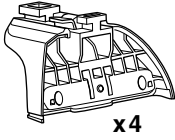

x4



x4



x4



x8

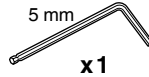

x1



x4



x1

460R

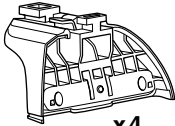

x4



x4



x4



x8



x1



x4

460

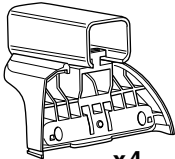

x4



x4



x4



x8

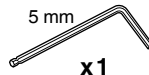

x1



x4

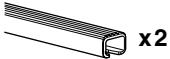

x2



x1

17 mm



x2

23 mm



x2

23 mm

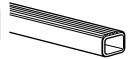

x2



x2

23 mm

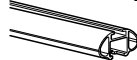

x2

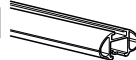

x2

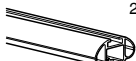

x2



x4



x4



x4

1

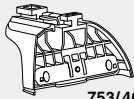

753/460R

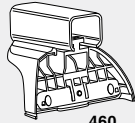

460

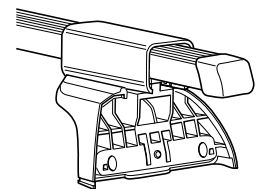
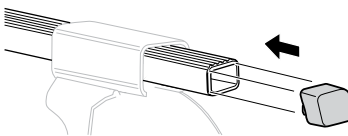
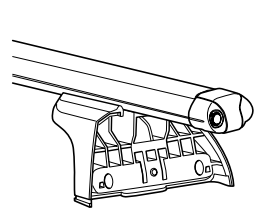
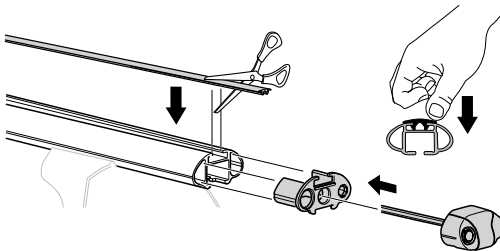
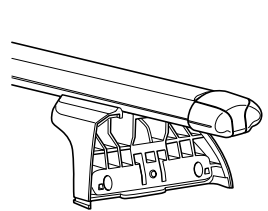
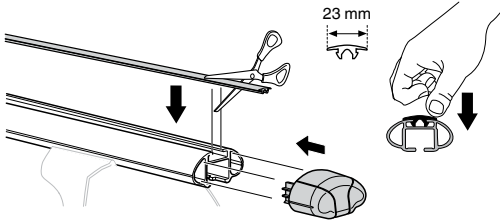
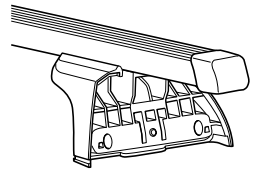
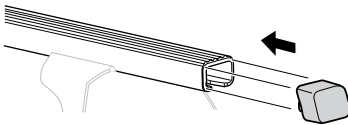
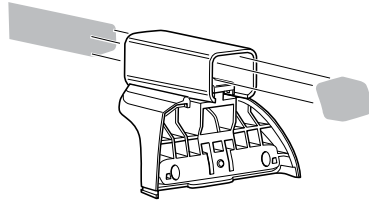
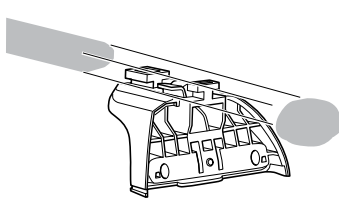

2

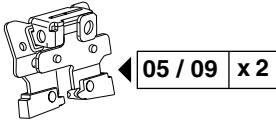

05 / 09 x 2

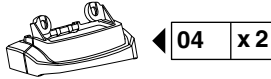

04 x 2

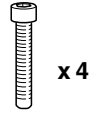

x 4

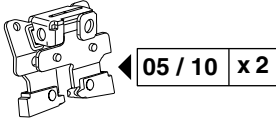

05 / 10 x 2

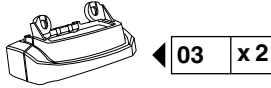

03 x 2



x 4

05/10

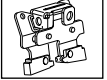

03

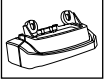

05/09

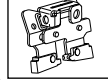

04



05/09

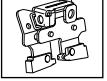

04

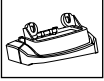

05/10

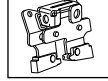

03

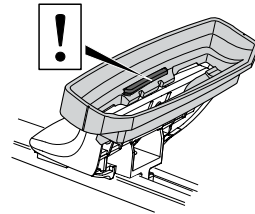
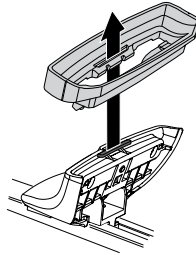
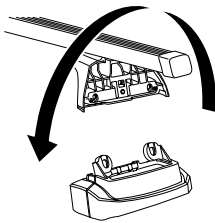
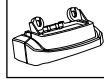

i

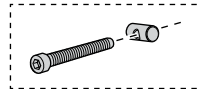

i

GB Only a few turns
D Nur wenige Umdrehungen
F Quelques tours uniquement
NL Slechts enkele slagen
I Solo qualche giro
E Sólo algunas vueltas
PT Noções básicas
S Endast några varv
FIN Vain muutama kierros

EST Ainult mõni pööre
LAT Tikai dažī apgriezieni
LIT Tik keli pasukimai
PL Wystarczy kilka obrotów
RU Достаточно нескольких оборотов
CZ Pouze několik otáček
SK Len niekoľko otáčok
SLO Le nekaj obratov

HR Samo nekoliko okreta
HU Csak néhány fordítás
GR Μόνο μερικές στροφές
TR Yalnız birkaç kez çevirm
中文 只有几个转向
한국어 두 세번만
日本語 数回転のみ
ไทย หมุนเพียงไม่กี่รอบ

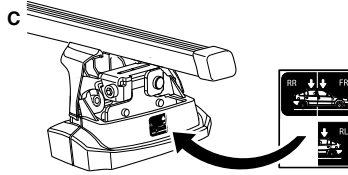
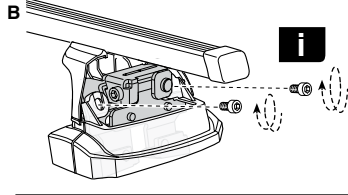
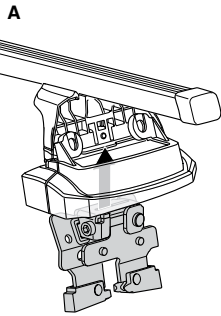
316 mm  x 8

- i** GB Only a few turns
 D Nur wenige Umdrehungen
 F Quelques tours uniquement
 NL Slechts enkele slagen
 I Solo qualche giro
 E Sólo algunas vueltas
 PT Noções básicas
 S Endast några varv
 FIN Vain muutama kierros
 EST Ainult mõni pööre
 LAT Tikai dažī apgriezieni
 LIT Tik keli pasukimai
 PL Wystarczy kilka obrotów
 RU Достаточно нескольких оборотов
 CZ Pouze několik otáček
 SK Len niekoľko otáčok
 SLO Le nekaj obratov
 HR Samo nekoliko okreta
 HU Csak néhány fordítás
 GR Μόνο μερικές στροφές
 TR Yalnız birkaç kez çevirm
 中文 只有几个转向
 한국어 두 세번만
 日本語 数回転のみ
 ไทย หมุนเพียงไม่กี่รอบ

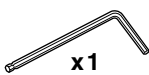
4

x1

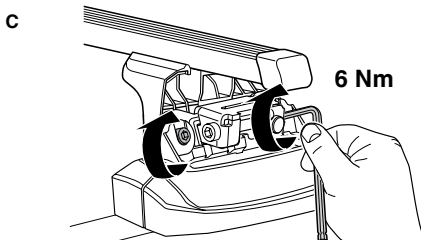
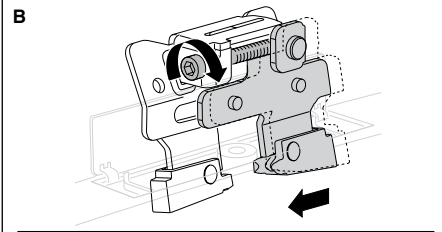
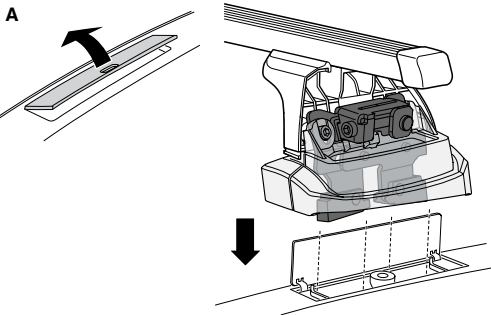
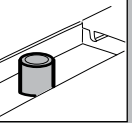
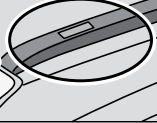
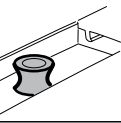
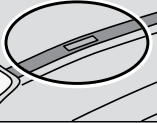
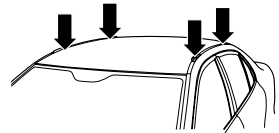
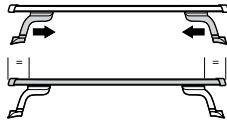

6 Nm

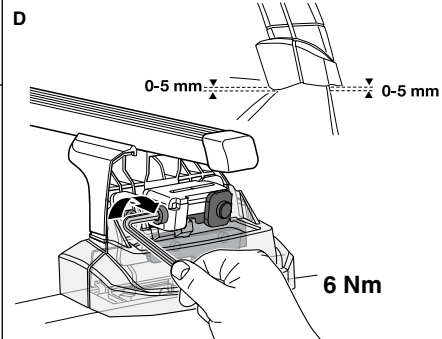

0-5 mm

0-5 mm

6 Nm

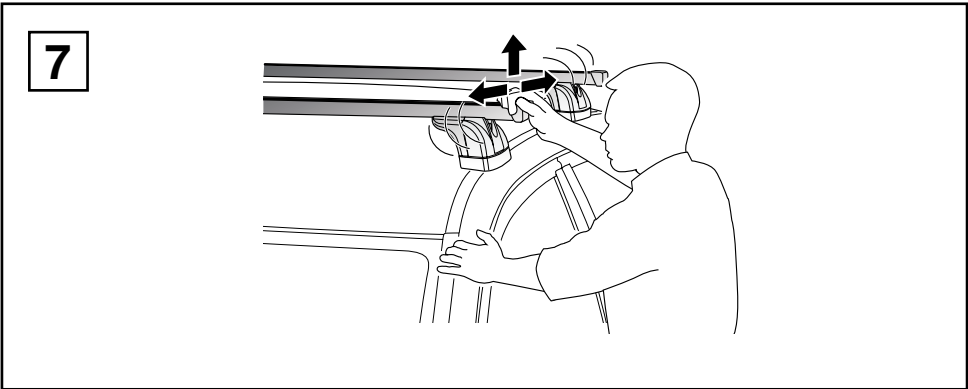
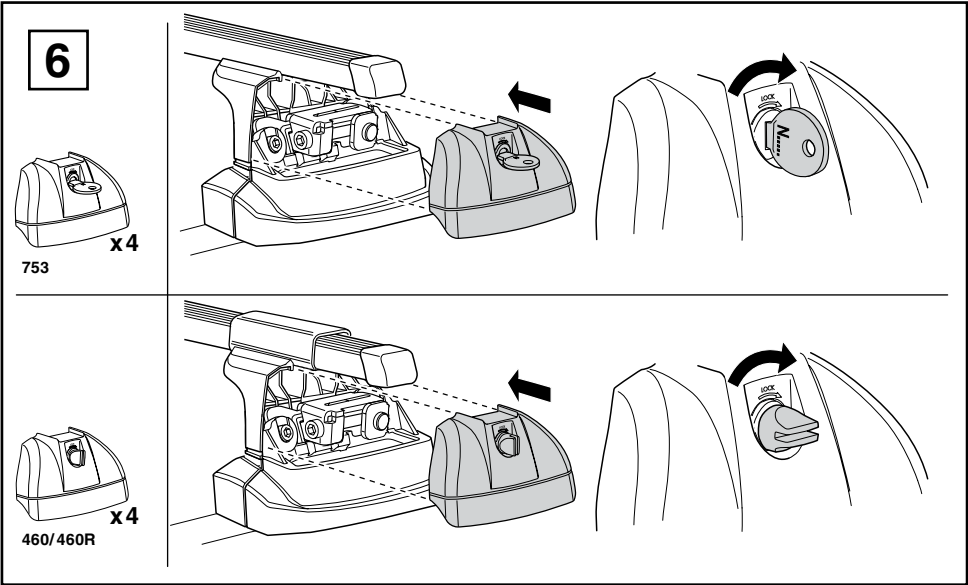
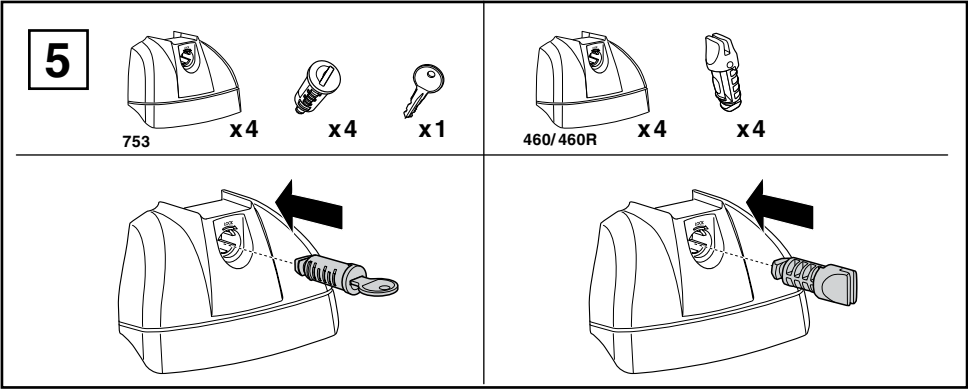

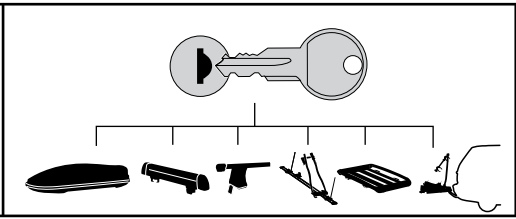
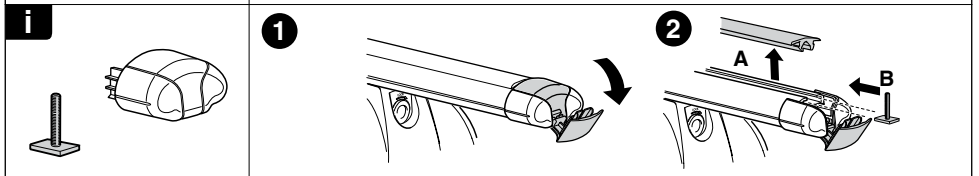
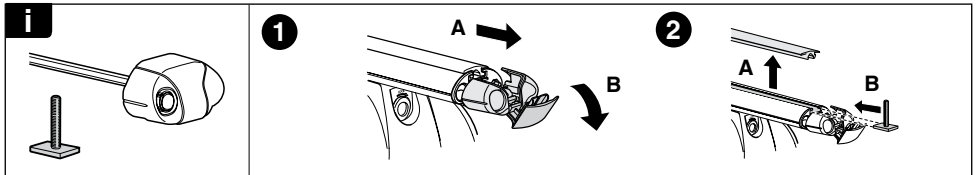
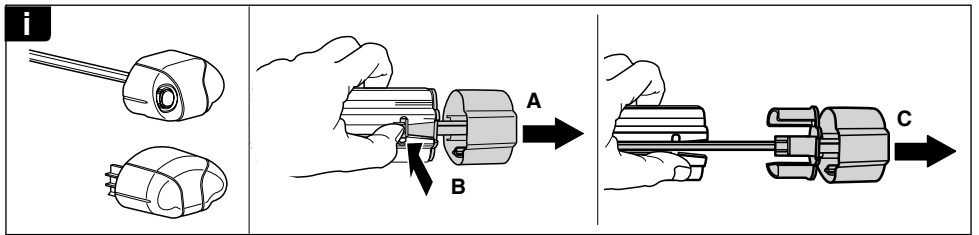
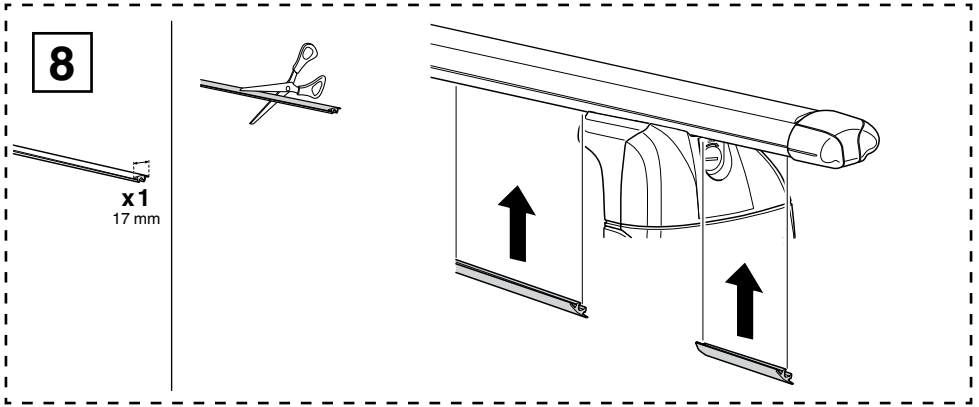

- 544 (x4)
- 596 (x6)
- 588 (x8)
- NA 510 (x10)
- EUR 452 (x12)
- ASIA

WW ▶ Thule Sweden AB, Box 69, 330 33 Hillerstorp, SWEDEN
 NA ▶ Thule Inc., 42 Silvermine Road, Seymour, Connecticut 06483, USA

info@thule.com
 customer.service@thule.com

www.thule.com