

Kit 1182

MITSUBISHI Pajero, 5-dr SUV, 99-06

MITSUBISHI Montero, 5-dr SUV, 99-06

480R
754

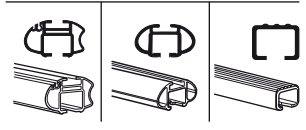
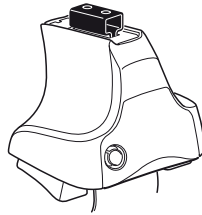

480

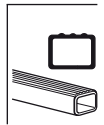
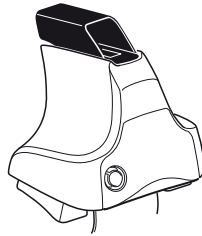

750

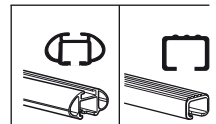
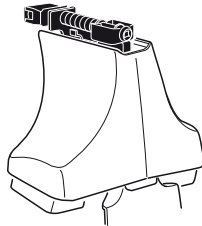

THULE[®]
SWEDEN

ISO 11154-E

Kit



3



754

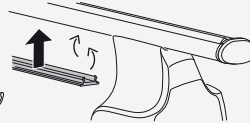
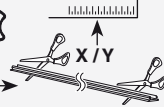

750



1

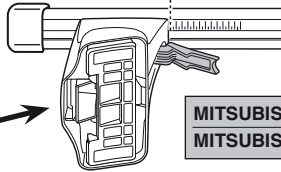
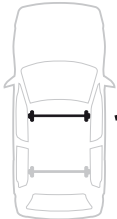

2

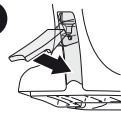

	X
MITSUBISHI Pajero, 5-dr SUV, 99-06	44,5
MITSUBISHI Montero, 5-dr SUV, 99-06	44,5

1

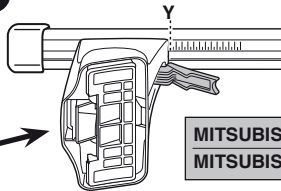
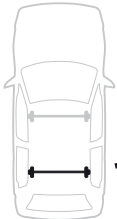

2

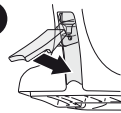

	Y
MITSUBISHI Pajero, 5-dr SUV, 99-06	44,5
MITSUBISHI Montero, 5-dr SUV, 99-06	44,5



480R



480

1

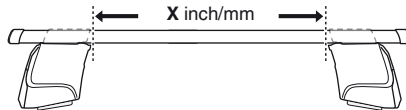
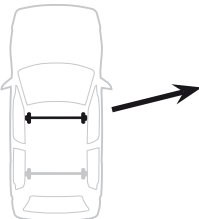

2

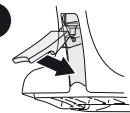

	X inch	X mm
MITSUBISHI Pajero, 5-dr SUV, 99-06	43 1/8"	1096 mm
MITSUBISHI Montero, 5-dr SUV, 99-06	43 1/8"	1096 mm

1

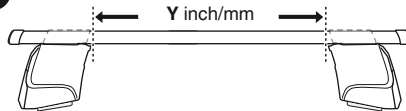
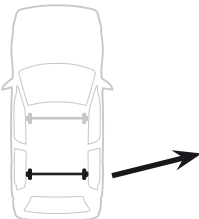

2

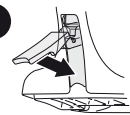

	Y inch	Y mm
MITSUBISHI Pajero, 5-dr SUV, 99-06	43 1/8"	1096 mm
MITSUBISHI Montero, 5-dr SUV, 99-06	43 1/8"	1096 mm

4

MITSUBISHI Pajero, 5-dr SUV, 99-06
 MITSUBISHI Montero, 5-dr SUV, 99-06

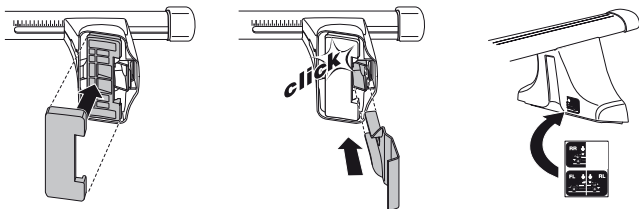
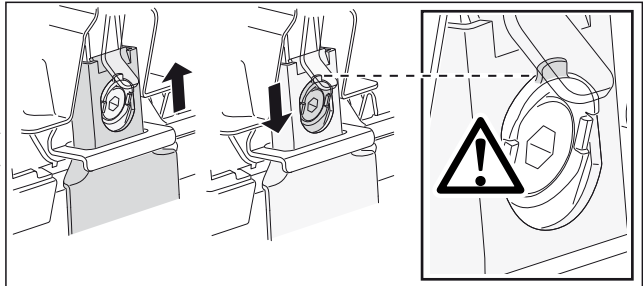
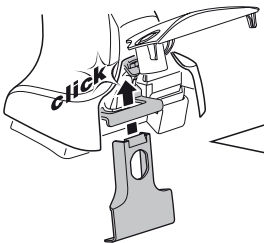
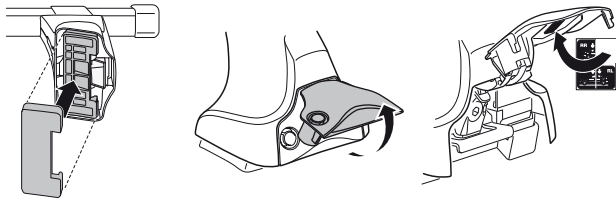
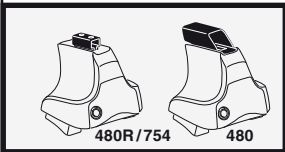
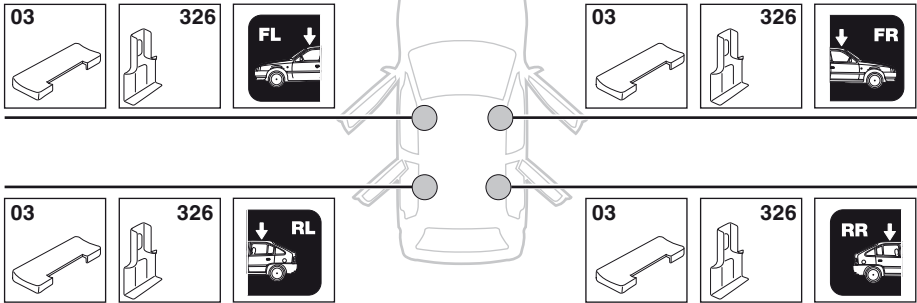

5



	X mm	Y mm	X inch	Y inch
MITSUBISHI Pajero, 5-dr SUV, 99-06	595 mm	750 mm	23 3/8"	29 1/2"
MITSUBISHI Montero, 5-dr SUV, 99-06	595 mm	750 mm	23 3/8"	29 1/2"

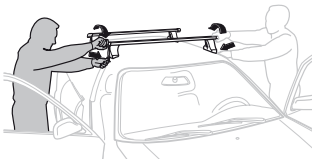
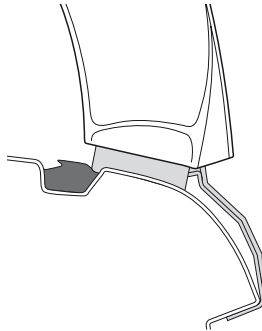
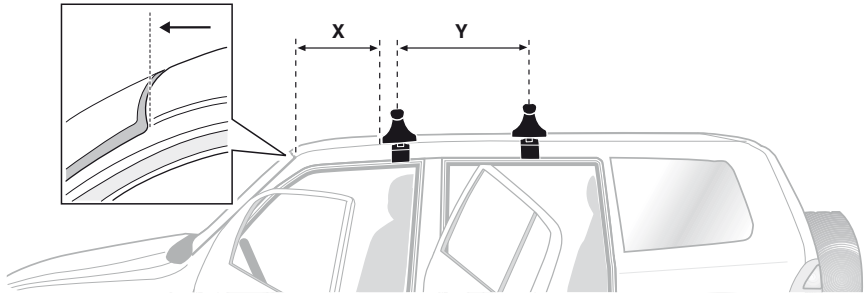

- GB/US** Tighten alternately
D Die Schrauben abwechselnd anziehen
F Serrer alternativement chaque côté
NL Afwisselend aan de linker- en de rechterkant aandraaien
I Alternare il serraggio delle viti
E Apretar alternativamente
PT Aperte alternadamente
S Dra åt växelvis
FIN Kierrä vuorotellen
EST Pinguldage vaheldumisi
LAT Pievelciēt pamišus
LIT Užsukinėkite pakaitomis
PL Śruby dokręcaj naprzemiennie
RU Затягивайте попеременно

- CZ** Pokręťtia bagazníka dokręcaj dokręcaj naprzemiennie.
SK Doťahujte striedavo
SLO Privijajte izmenično.
HR Naizmjenično zategnite
HU Egymástól függetlenül szorítandó
GR Σφιγίγστε εναλλάξ
TR Dönüşümlü sıkın

中文 交替拧紧

한국어 번갈아 가며 조이십시오.

日本語 交互に締め付けてください。

ไทย ชับในแบบสลับ

6

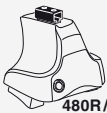

480R/754



480

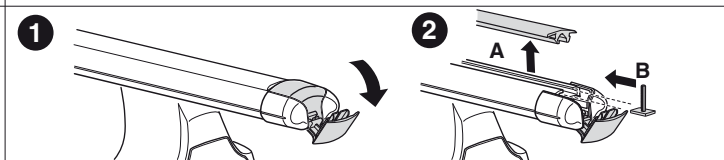
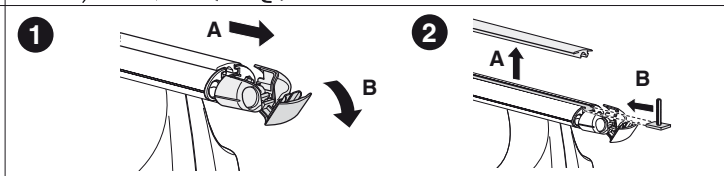
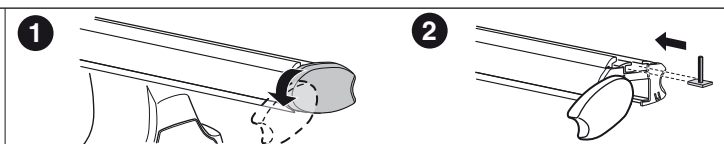
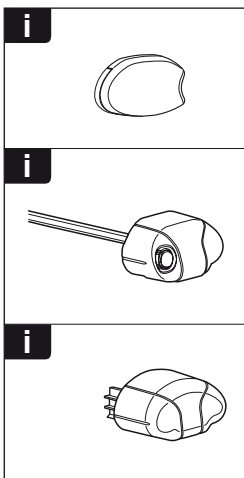
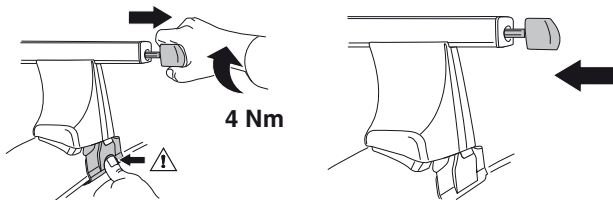
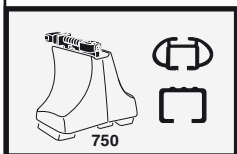
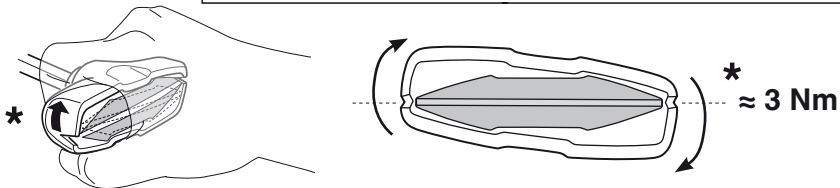
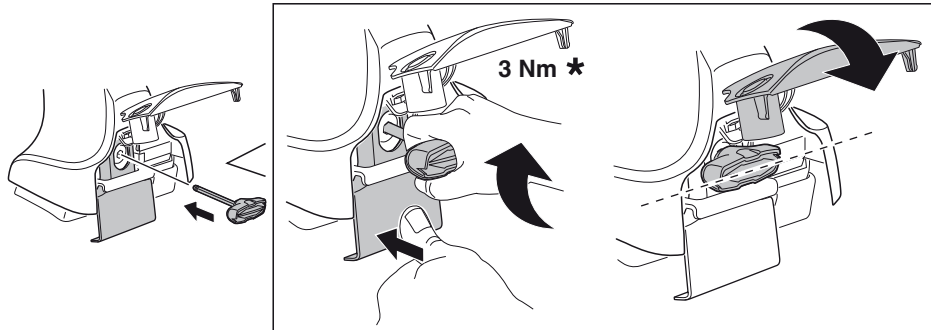

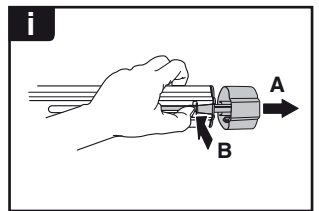
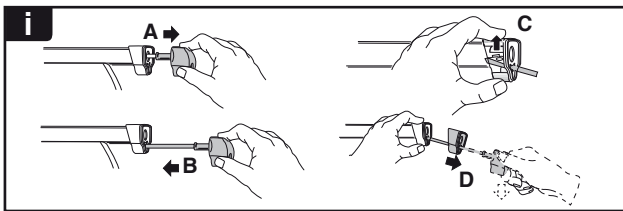
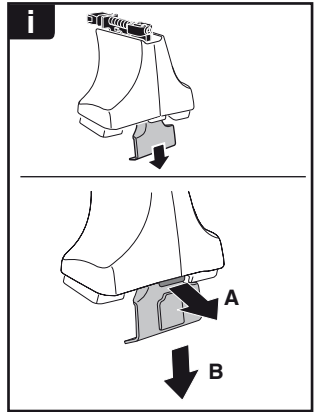
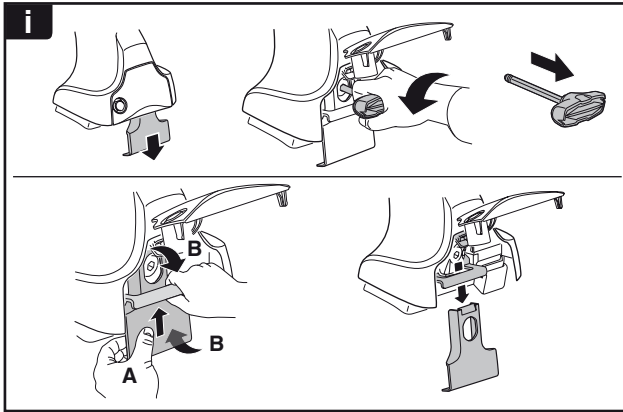

THULE
SWEDEN
**ONE
KEY
SYSTEM**

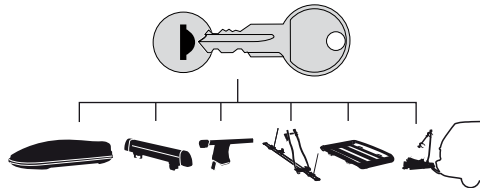

- 544 (x4)
- 596 (x6)
- 588 (x8)
- NA 510 (x10)
- EUR 452 (x12)
- ASIA



WW ▶ Thule Sweden AB, Box 69, 330 33 Hillerstorp, SWEDEN
NA ▶ Thule Inc., 42 Silvermine Road, Seymour, Connecticut 06483, USA

info@thule.com
customer.service@thule.com

www.thule.com