

Kit 1150

HONDA HR-V, 3-dr SUV, 99-01, 02-05*

HONDA HR-V, 5-dr SUV, 00-01, 02-05*

* With normal roof

480R
754

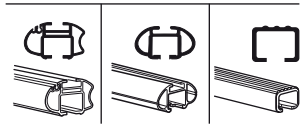
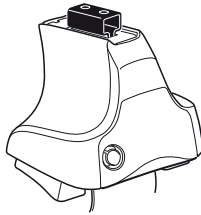

480

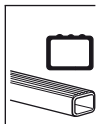
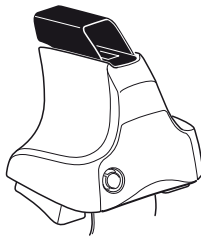

750

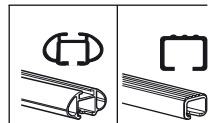
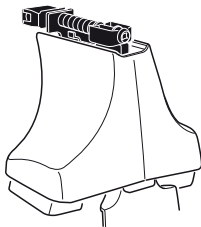

xx kg
 xx lbs

7 kg
 15,4 lbs

Max. 75kg
Max. 165 lbs

80 km/h 50 Mph
 130 km/h 80 Mph
 40 km/h 25 Mph
km/h Mph

THULE

Kit XXXX
 instructions

x1

x4

x4

x4

480R/754

x1

x4

x4

x4

480

x1

x4

x4

750

| | | | | |
|----------------------|----|----------------------|----------|----|
| x2 x2 x2 x4 | x2 | x2 x2 x4 x4 | x2 x2 | x2 |
|----------------------|----|----------------------|----------|----|

146 x2

153 x2

07 x4

x1

Kit

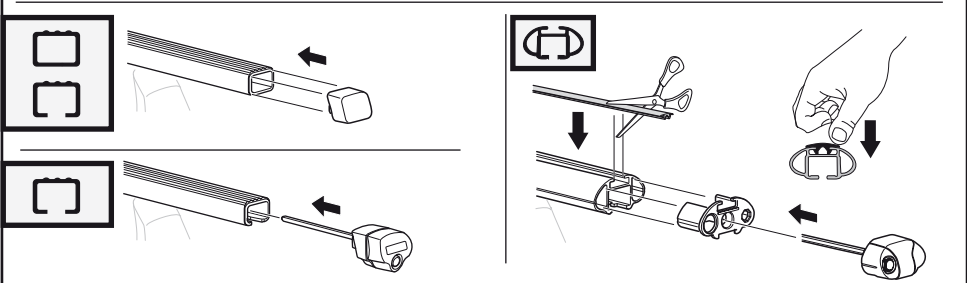
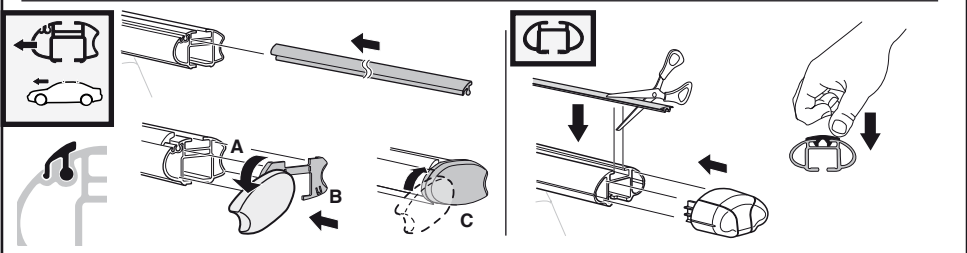
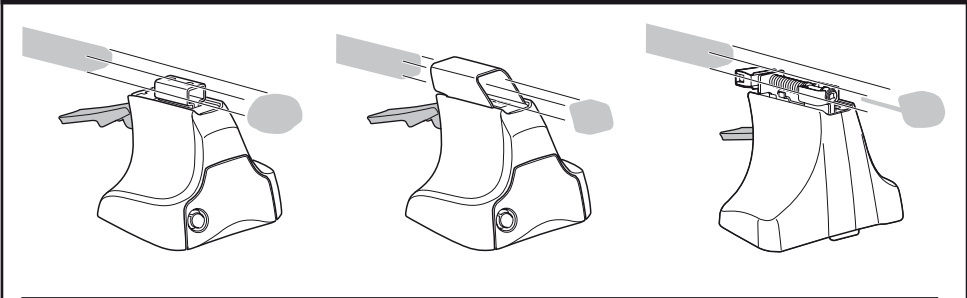
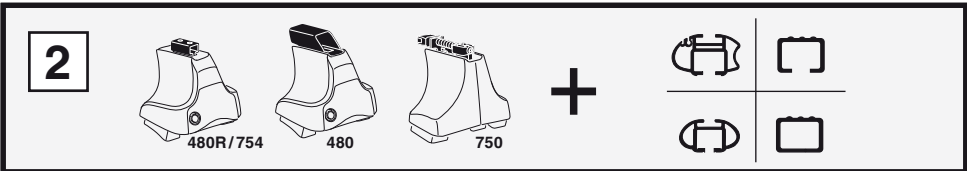
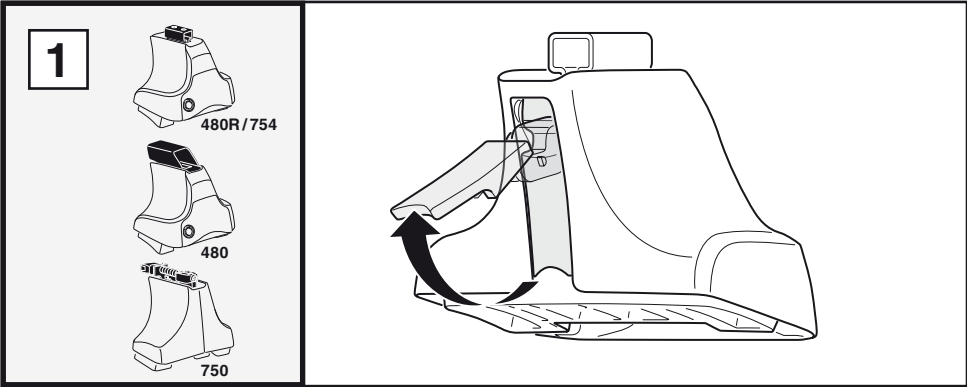

3

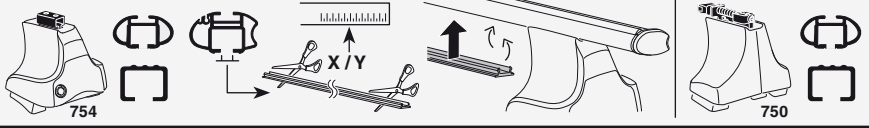

1

2

| | X |
|------------------------------------|------|
| HONDA HR-V, 3-dr SUV, 99-01, 02-05 | 46,5 |
| HONDA HR-V, 5-dr SUV, 00-01, 02-05 | 45,5 |

1

2

| | Y |
|------------------------------------|------|
| HONDA HR-V, 3-dr SUV, 99-01, 02-05 | 44 |
| HONDA HR-V, 5-dr SUV, 00-01, 02-05 | 43,5 |

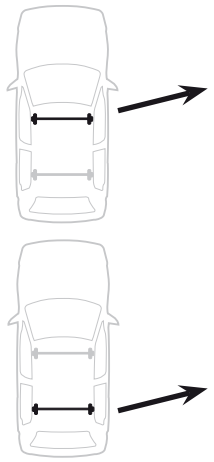
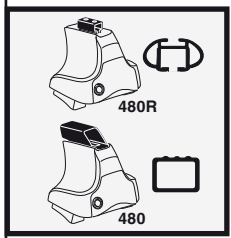

1

2

| | X inch | X mm |
|------------------------------------|----------------------------------|---------|
| HONDA HR-V, 3-dr SUV, 99-01, 02-05 | 43 ⁷ / ₈ " | 1116 mm |
| HONDA HR-V, 5-dr SUV, 00-01, 02-05 | 43 ¹ / ₂ " | 1106 mm |

1

2

| | Y inch | Y mm |
|------------------------------------|----------------------------------|---------|
| HONDA HR-V, 3-dr SUV, 99-01, 02-05 | 43 " | 1091 mm |
| HONDA HR-V, 5-dr SUV, 00-01, 02-05 | 42 ³ / ₄ " | 1086 mm |

4

HONDA HR-V, 3-dr SUV, 99-01, 02-05

HONDA HR-V, 5-dr SUV, 00-01, 02-05

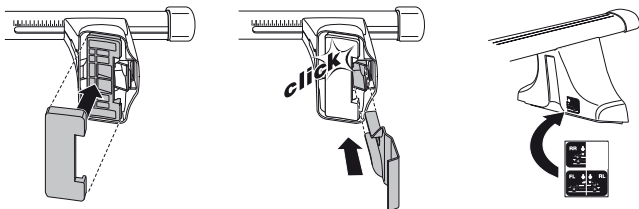
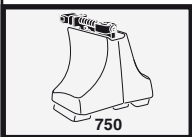
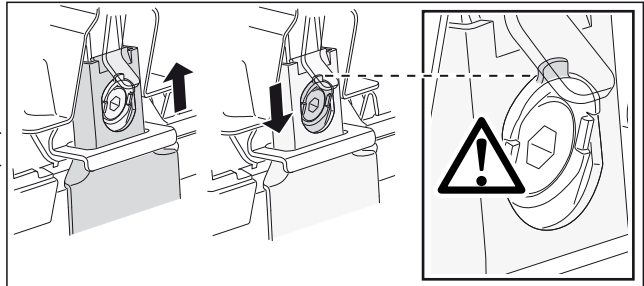
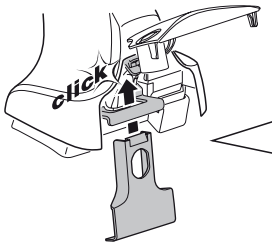
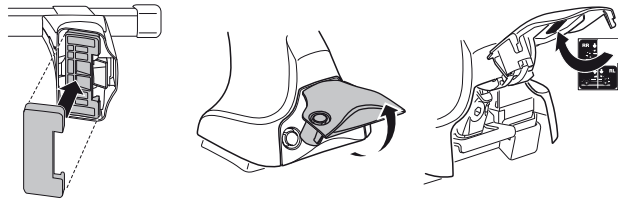
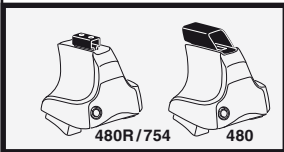
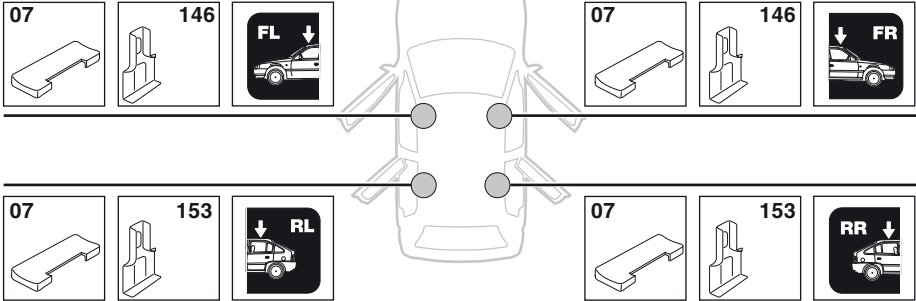

5

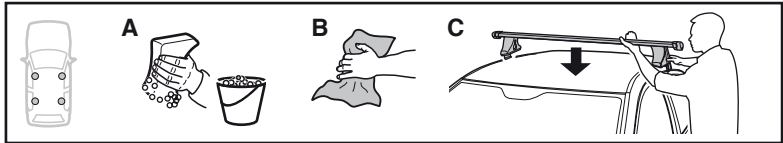

| | X mm | Y mm | X inch | Y inch |
|------------------------------------|--------|--------|---------|---------|
| HONDA HR-V, 3-dr SUV, 99-01, 02-05 | 400 mm | 700 mm | 15 3/4" | 27 1/2" |
| HONDA HR-V, 5-dr SUV, 00-01, 02-05 | 400 mm | 700 mm | 15 3/4" | 27 1/2" |

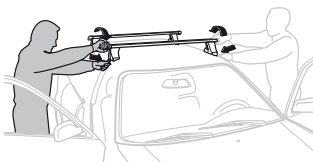
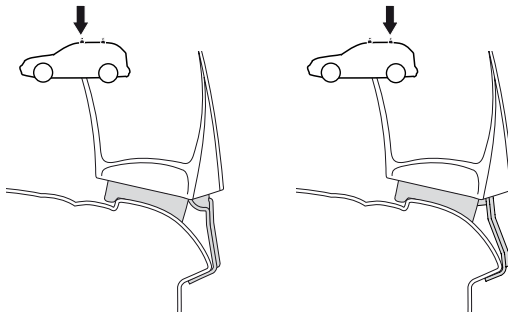
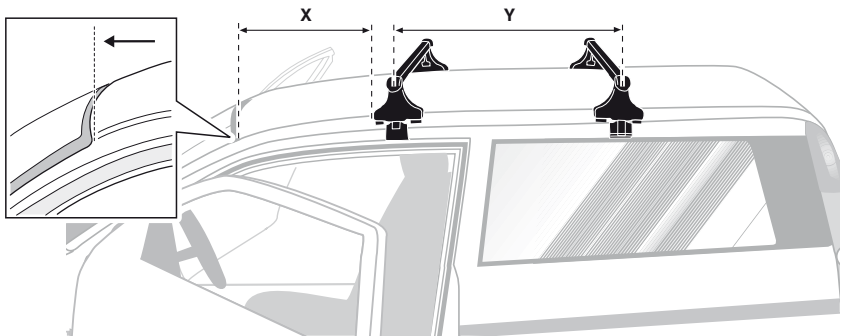

- | | | | |
|--------------|---|------------|---|
| GB/US | Tighten alternately | CZ | Pokřeřta bagažníka dokřeřcaj dokřeřcaj napržeimennie. |
| D | Die Schrauben abwechselnd anziehen | SK | Dotahujte striedavo |
| F | Serrer alternativement chaque côté | SLO | Privijajte izmenično. |
| NL | Afwisselend aan de linker- en de rechterkant aandraaien | HR | Naizmjenično zategnite |
| I | Alternare il serraggio delle viti | HU | Egymástól függetlenül szorítandó |
| E | Apretar alternativamente | GR | Σφιγγετε ενυλάξ |
| PT | Aperte alternadamente | TR | Dönüşümlü sıkın |
| S | Dra åt växelvis | 中文 | 交替拧紧 |
| FIN | Kierrä vuorotellen | 한국어 | 번갈아 가며 조이십시오. |
| EST | Pinguldage vaheldumisi | 日本語 | 交互に締め付けてください。 |
| LAT | Pielvelciēt pamišus | ไทย | ขันในแบบสลับ |
| LIT | Užsukinėkite pakaitomis | | |
| PL | Śruby dokřeřcaj napržeimennie | | |
| RU | Затягивайте попеременно | | |

6



480R/754



480

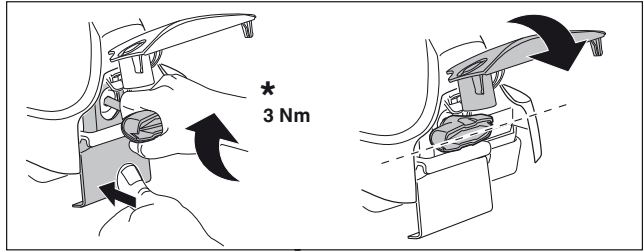
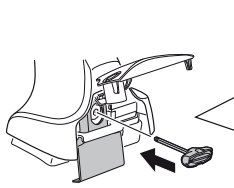

*
3 Nm

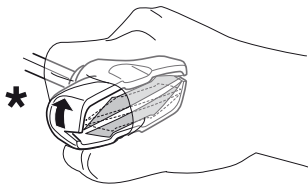

*

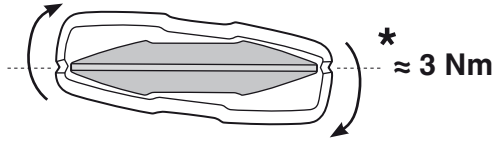

*
≈ 3 Nm

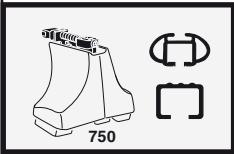
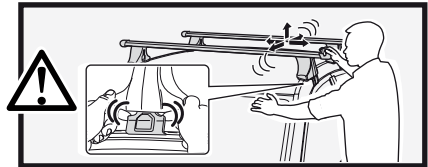

750

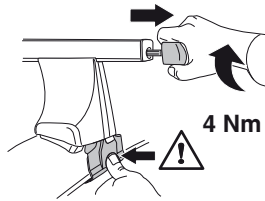

4 Nm

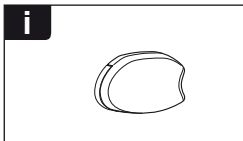
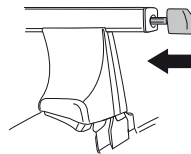

i

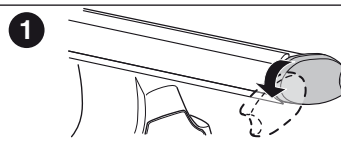

1

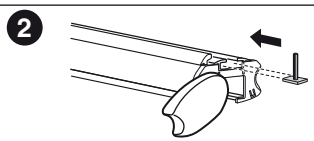

2

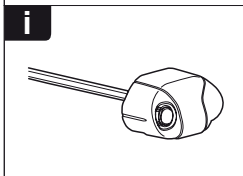

i

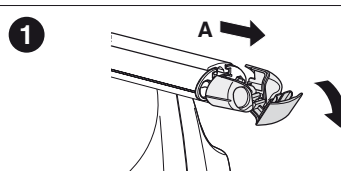

1

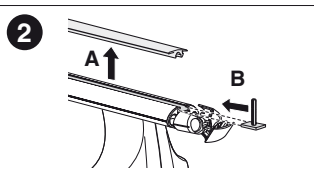

2

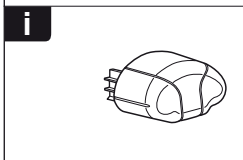

i

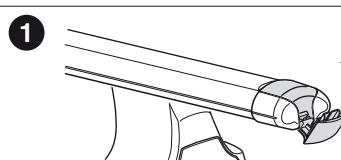

1

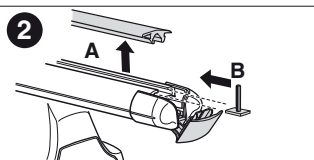



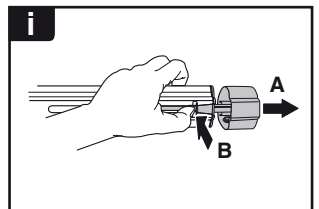
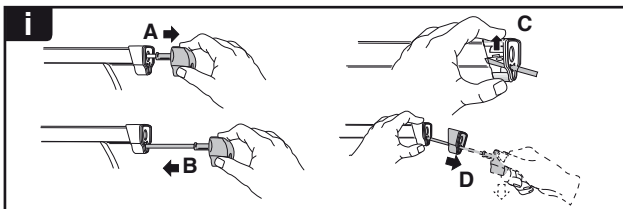
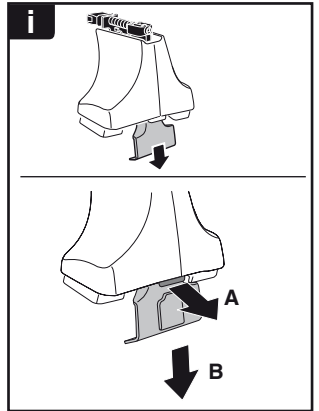
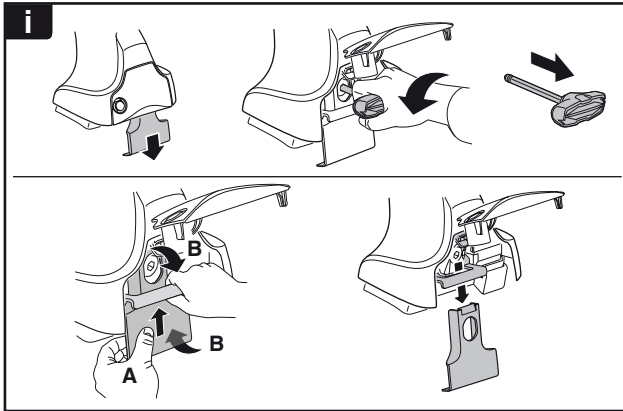
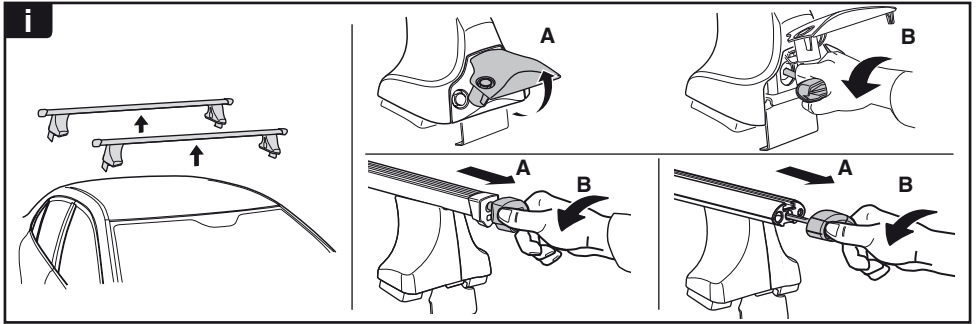

2

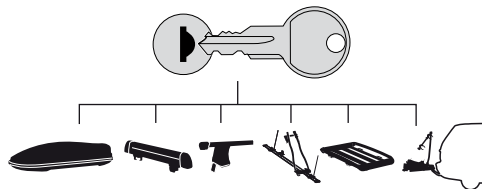

THULE
SWEDEN
**ONE
KEY
SYSTEM**



-  **544** (x4)
-  **596** (x6)
-  **588** (x8)
- NA  **510** (x10)
- EUR  **452** (x12)
- ASIA

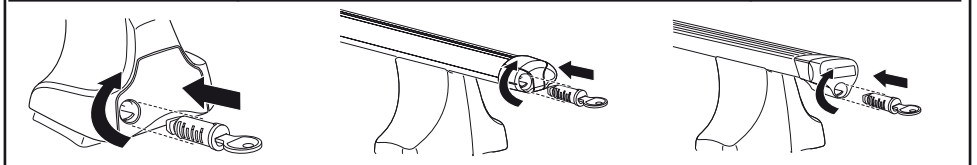

WW ▶ Thule Sweden AB, Box 69, 330 33 Hillerstorp, SWEDEN
NA ▶ Thule Inc., 42 Silvermine Road, Seymour, Connecticut 06483, USA

info@thule.com
customer.service@thule.com

 www.thule.com