

Kit 1045

HONDA Civic, 5-dr Hatchback, 95-99 (JPN)

HONDA Civic, 5-dr Hatchback, 95-00 (EUR)

MG ZS, 4-dr Sedan, 02-

MG ZS, 5-dr Hatchback, 02-

ROVER 400, 4-dr Sedan, 96-99

ROVER 400, 5-dr Hatchback, 96-99

ROVER 45, 4-dr Sedan, 00-03, 04-

ROVER 45, 5-dr Hatchback, 00-03, 04-

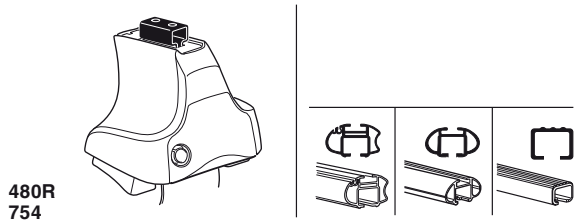

480R
754

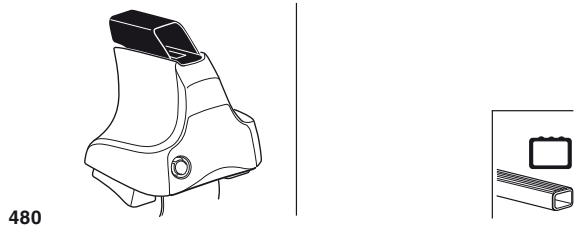

480

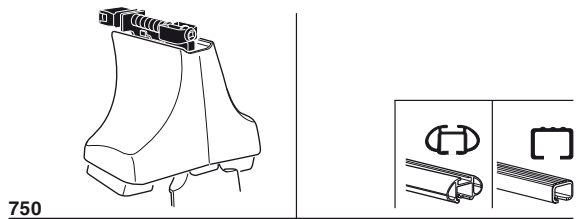

750

x2 x2 x2 x4	x2	x2 x2 x4 x4	x2 x2	x2	x2

149 x 2
 150 x 2
 15 x 4
 x 1

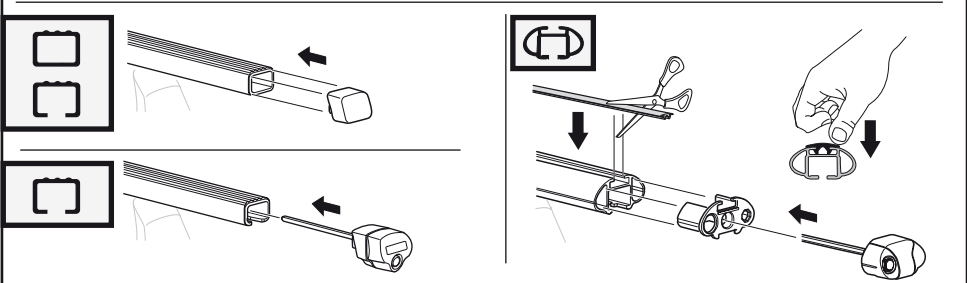
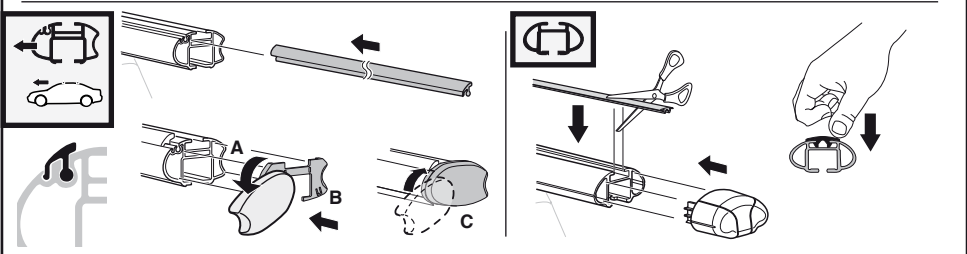
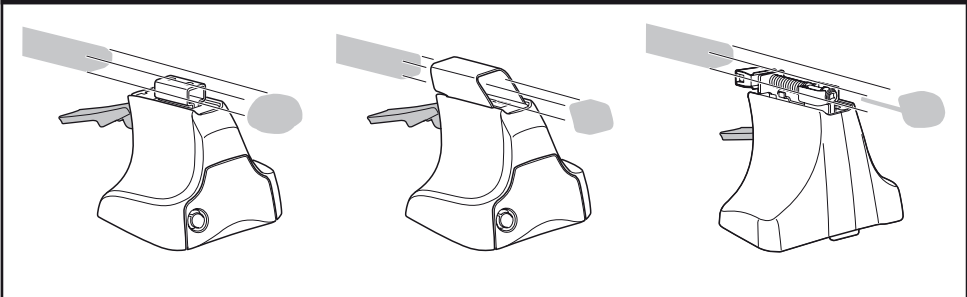
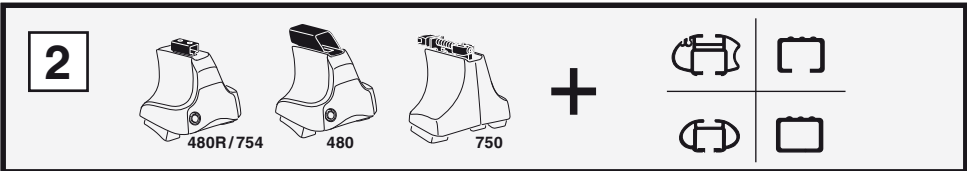
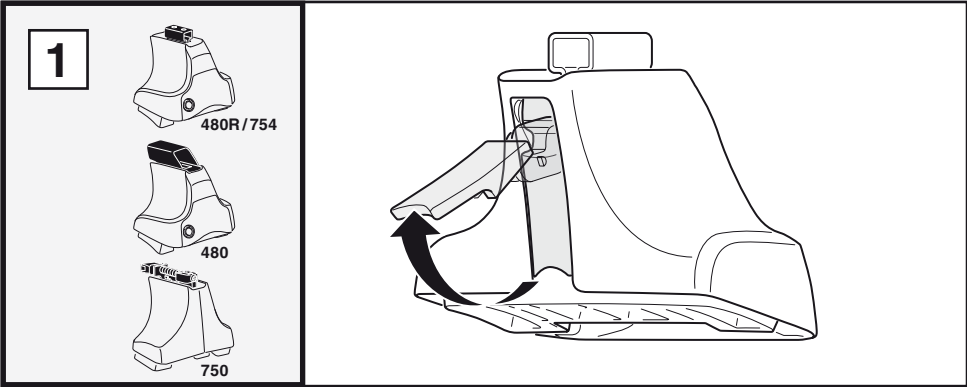

3

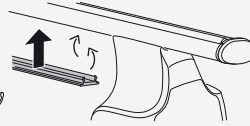
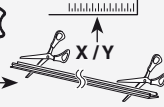
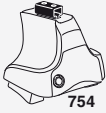

1

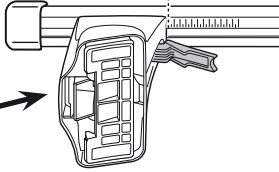

2

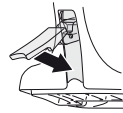

X

HONDA Civic , 5-dr Hatchback, 95-99 (JPN)	26,5
HONDA Civic , 5-dr Hatchback, 95-00 (EUR)	26,5
MG ZS , 4-dr Sedan, 02-	26,5
MG ZS , 5-dr Hatchback, 02-	26,5
ROVER 400 , 4-dr Sedan, 96-99	26,5
ROVER 400 , 5-dr Hatchback, 96-99	26,5
ROVER 45 , 4-dr Sedan, 00-03, 04-	26,5
ROVER 45 , 5-dr Hatchback, 00-03, 04-	26,5

1

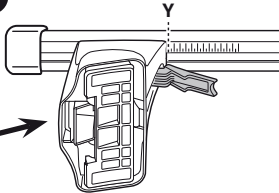

2

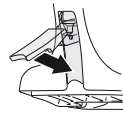

Y

HONDA Civic , 5-dr Hatchback, 95-99 (JPN)	25
HONDA Civic , 5-dr Hatchback, 95-00 (EUR)	25
MG ZS , 4-dr Sedan, 02-	25
MG ZS , 5-dr Hatchback, 02-	25
ROVER 400 , 4-dr Sedan, 96-99	25
ROVER 400 , 5-dr Hatchback, 96-99	25
ROVER 45 , 4-dr Sedan, 00-03, 04-	25
ROVER 45 , 5-dr Hatchback, 00-03, 04-	25

3

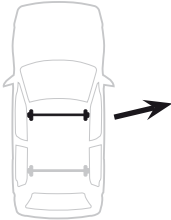
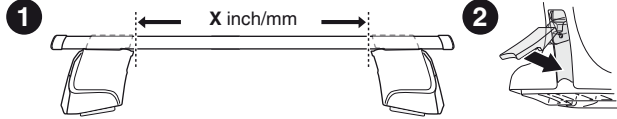

	X inch	X mm
HONDA Civic , 5-dr Hatchback, 95-99 (JPN)	36 $\frac{1}{8}$ "	916 mm
HONDA Civic , 5-dr Hatchback, 95-00 (EUR)	36 $\frac{1}{8}$ "	916 mm
MG ZS , 4-dr Sedan, 02-	36 $\frac{1}{8}$ "	916 mm
MG ZS , 5-dr Hatchback, 02-	36 $\frac{1}{8}$ "	916 mm
ROVER 400 , 4-dr Sedan, 96-99	36 $\frac{1}{8}$ "	916 mm
ROVER 400 , 5-dr Hatchback, 96-99	36 $\frac{1}{8}$ "	916 mm
ROVER 45 , 4-dr Sedan, 00-03, 04-	36 $\frac{1}{8}$ "	916 mm
ROVER 45 , 5-dr Hatchback, 00-03, 04-	36 $\frac{1}{8}$ "	916 mm

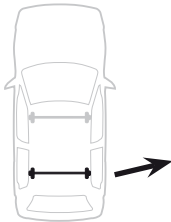
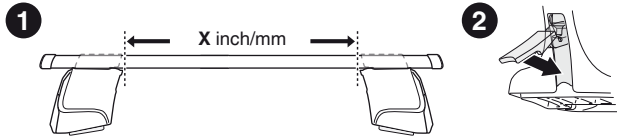

	Y inch	Y mm
HONDA Civic , 5-dr Hatchback, 95-99 (JPN)	35 $\frac{1}{2}$ "	901 mm
HONDA Civic , 5-dr Hatchback, 95-00 (EUR)	35 $\frac{1}{2}$ "	901 mm
MG ZS , 4-dr Sedan, 02-	35 $\frac{1}{2}$ "	901 mm
MG ZS , 5-dr Hatchback, 02-	35 $\frac{1}{2}$ "	901 mm
ROVER 400 , 4-dr Sedan, 96-99	35 $\frac{1}{2}$ "	901 mm
ROVER 400 , 5-dr Hatchback, 96-99	35 $\frac{1}{2}$ "	901 mm
ROVER 45 , 4-dr Sedan, 00-03, 04-	35 $\frac{1}{2}$ "	901 mm
ROVER 45 , 5-dr Hatchback, 00-03, 04-	35 $\frac{1}{2}$ "	901 mm

4

HONDA Civic, 5-dr Hatchback, 95-99 (JPN)

HONDA Civic, 5-dr Hatchback, 95-00 (EUR)

MG ZS, 4-dr Sedan, 02-

MG ZS, 5-dr Hatchback, 02-

ROVER 400, 4-dr Sedan, 96-99

ROVER 400, 5-dr Hatchback, 96-99

ROVER 45, 4-dr Sedan, 00-03, 04-

ROVER 45, 5-dr Hatchback, 00-03, 04-

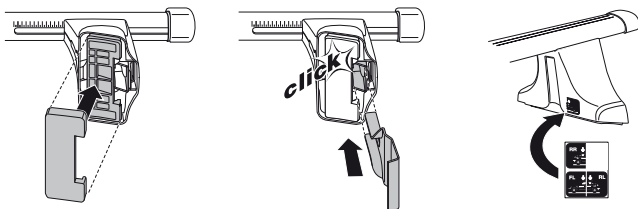
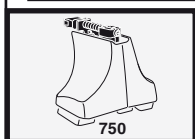
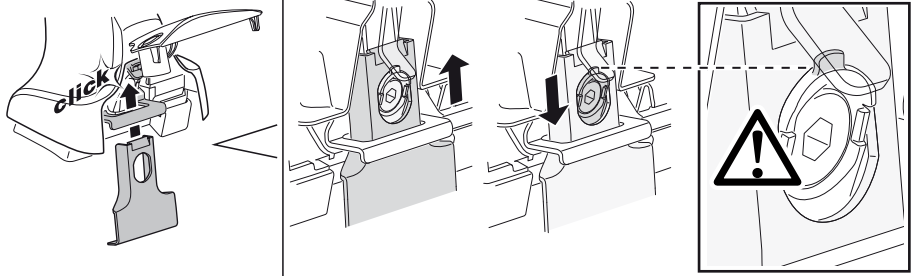
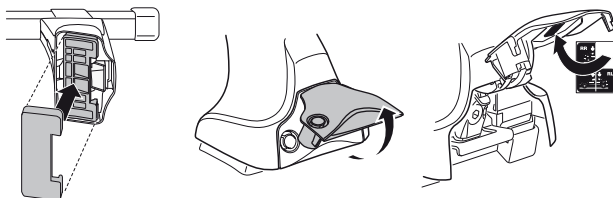
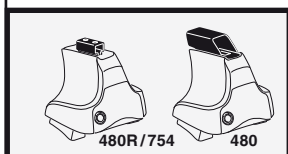
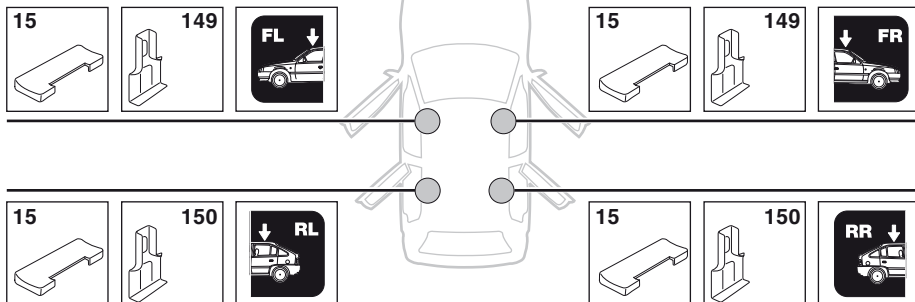

5

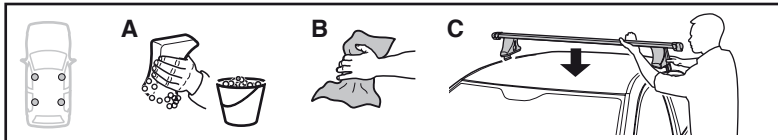

	X mm	Y mm	X inch	Y inch
HONDA Civic, 5-dr Hatchback, 95-99 (JPN)	160 mm	650 mm	6 1/4"	25 5/8"
HONDA Civic, 5-dr Hatchback, 95-00 (EUR)	160 mm	650 mm	6 1/4"	25 5/8"
MG ZS, 4-dr Sedan, 02-	160 mm	650 mm	6 1/4"	25 5/8"
MG ZS, 5-dr Hatchback, 02-	160 mm	650 mm	6 1/4"	25 5/8"
ROVER 400, 4-dr Sedan, 96-99	160 mm	650 mm	6 1/4"	25 5/8"
ROVER 400, 5-dr Hatchback, 96-99	160 mm	650 mm	6 1/4"	25 5/8"
ROVER 45, 4-dr Sedan, 00-03, 04-	160 mm	650 mm	6 1/4"	25 5/8"
ROVER 45, 5-dr Hatchback, 00-03, 04-	160 mm	650 mm	6 1/4"	25 5/8"

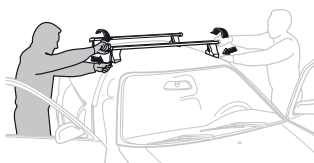
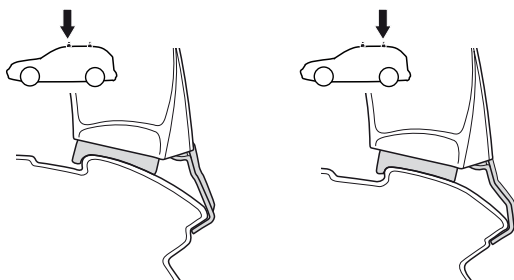
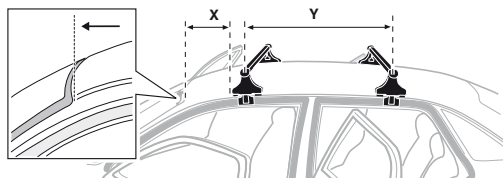

- | | | | |
|--------------|---|------------|--|
| GB/US | Tighten alternately | CZ | Pokręťta bagażníka dokręčaj dokręčaj naprziemiennie. |
| D | Die Schrauben abwechselnd anziehen | SK | Dofahujte striedavo |
| F | Serrer alternativement chaque côté | SLO | Privijajte izmenično. |
| NL | Afwisselend aan de linker- en de rechterkant aandraaien | HR | Naizmjenično zategnite |
| I | Alternare il serraggio delle viti | HU | Egymástól függetlenül szorítandó |
| E | Apertar alternativamente | GR | Σφίγγετε εναλλάξ |
| PT | Aperte alternadamente | TR | Dönüşümlü sıkın |
| S | Dra åt växelvis | 中文 | 交替拧紧 |
| FIN | Kierrä vuorotellen | 한국어 | 변갈아 가며 조이십시오. |
| EST | Pinguldage vaheldumisi | 日本語 | 交互に締め付けてください。 |
| LAT | Pielieciet pamišus | ไทย | ขันในแบบสลับ |
| LIT | Užsukinėkite pakaitomis | | |
| PL | Śruby dokręčaj naprzemiennie | | |
| RU | Затягивайте попеременно | | |

6



480R/754



480

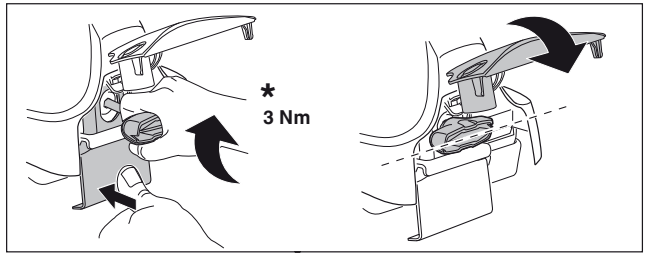
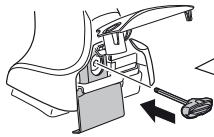

*
3 Nm

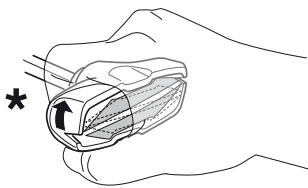

*

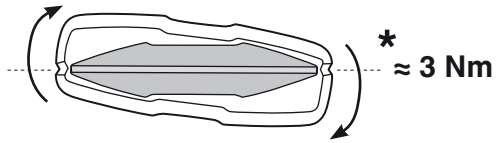

*
≈ 3 Nm

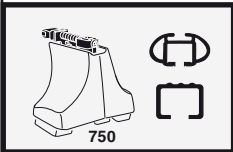
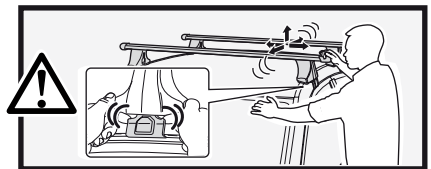

750

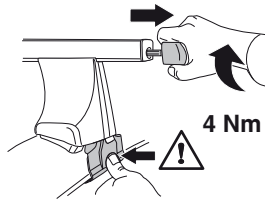

4 Nm

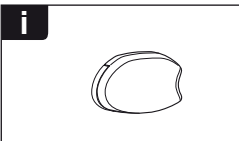
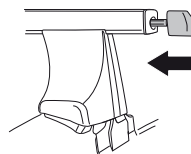

i

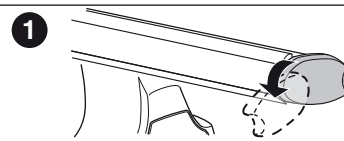

1

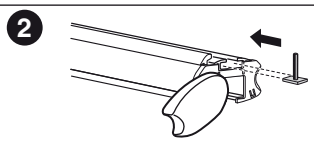

2

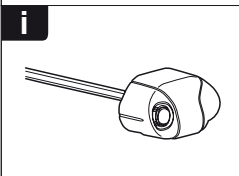

i

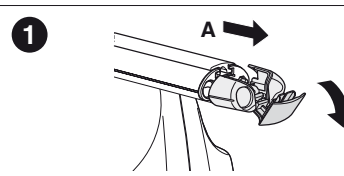

1

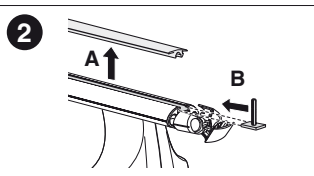

2

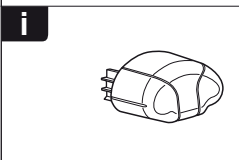

i

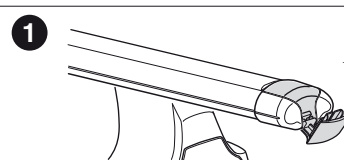

1

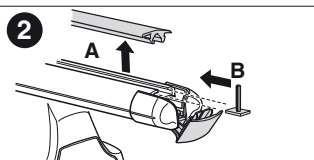

2

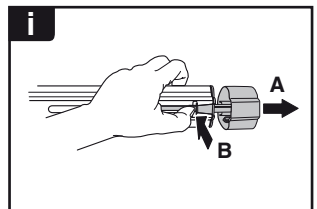
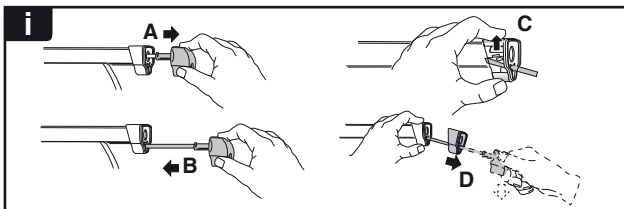
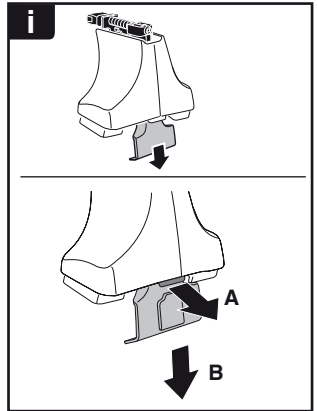
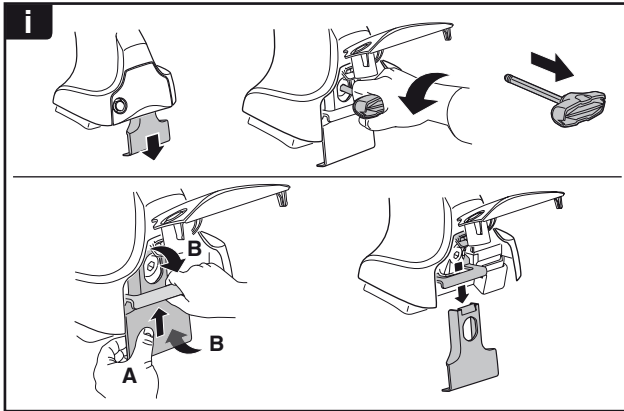
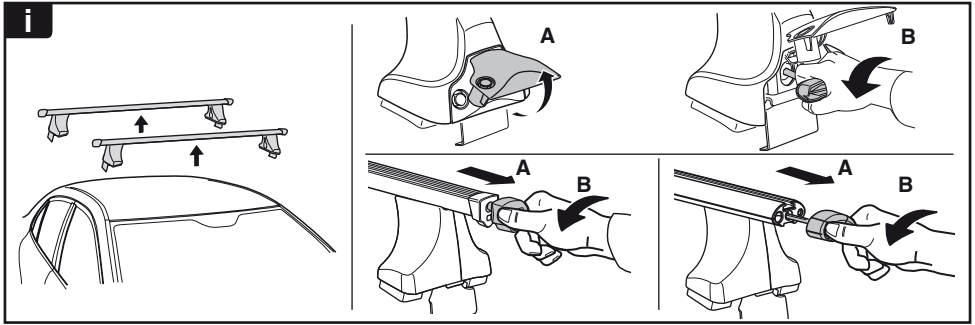

THULE
SWEDEN
**ONE
KEY
SYSTEM**

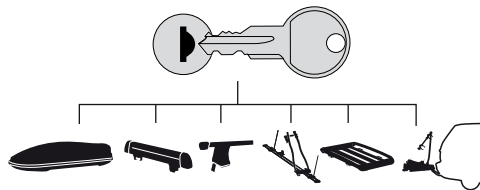

- 544 (x4)
- 596 (x6)
- 588 (x8)
- NA 510 (x10)
- EUR 452 (x12)
- ASIA

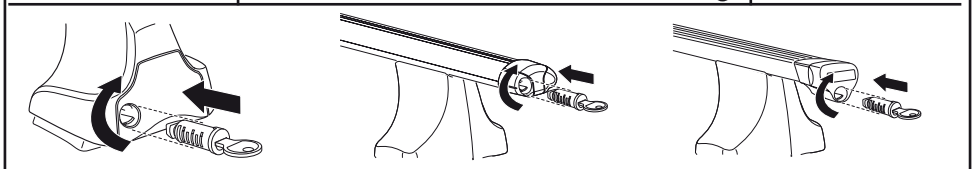

WW ▶ Thule Sweden AB, Box 69, 330 33 Hillerstorp, SWEDEN
NA ▶ Thule Inc., 42 Silvermine Road, Seymour, Connecticut 06483, USA

info@thule.com
customer.service@thule.com

www.thule.com