

Kit 1024

MAZDA 626, 5-dr Hatchback, 92-97

480R
754

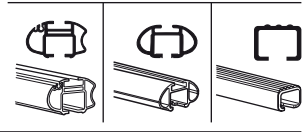
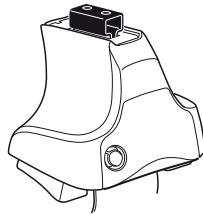

480

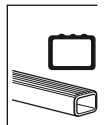
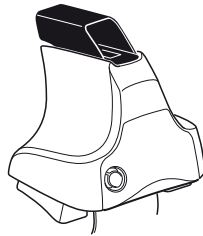

750

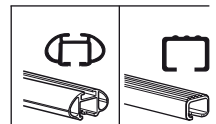
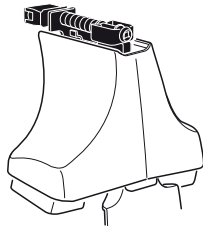

Kit



3



754

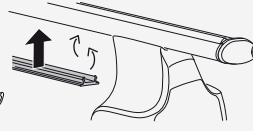
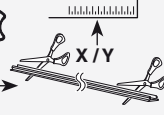

750

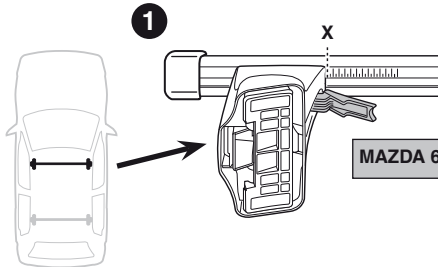

1

2

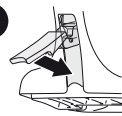

	X
MAZDA 626, 5-dr Hatchback, 92-97	30,5

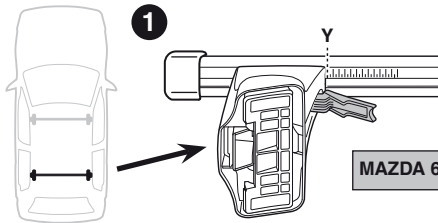

1

2

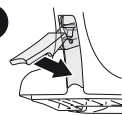

	Y
MAZDA 626, 5-dr Hatchback, 92-97	27,5



480R



480

1

2

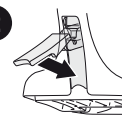
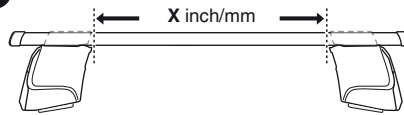

	X inch	X mm
MAZDA 626, 5-dr Hatchback, 92-97	37 5/8"	956 mm

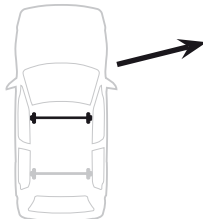

1

2

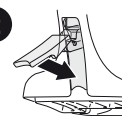
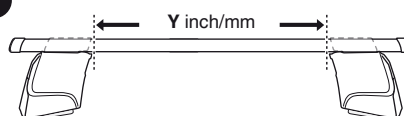

	Y inch	Y mm
MAZDA 626, 5-dr Hatchback, 92-97	36 1/2"	926 mm

4

MAZDA 626, 5-dr Hatchback, 92-97

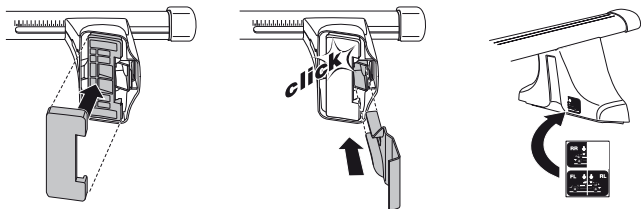
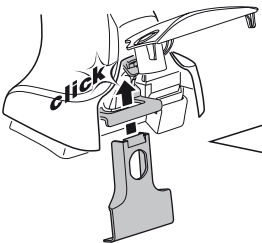
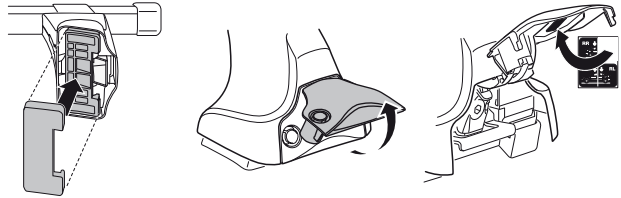
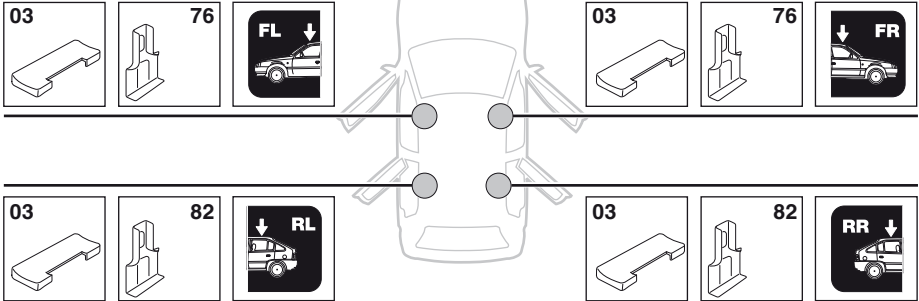

5

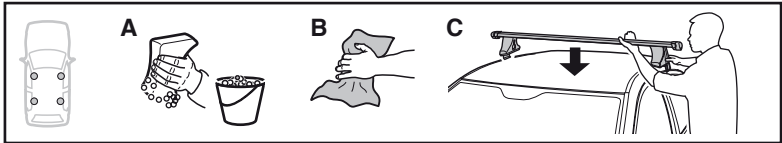

	X mm	Y mm	X inch	Y inch
MAZDA 626, 5-dr Hatchback, 92-97	290 mm	700 mm	11 ³ / ₈ "	27 ¹ / ₂ "

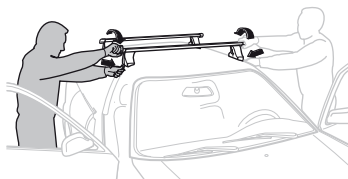
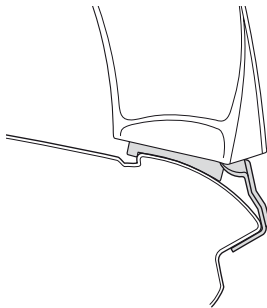
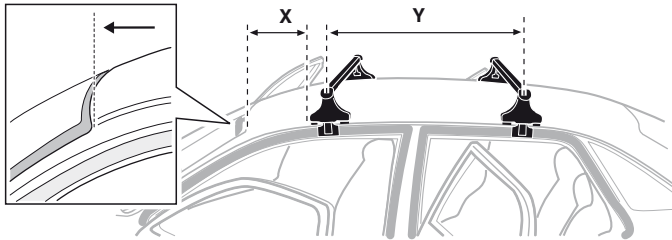

GB/US Tighten alternately

D Die Schrauben abwechselnd anziehen

F Serrer alternativement chaque côté

NL Afwisselend aan de linker- en de rechterkant aandraaien

I Alternare il serraggio delle viti

E Apretar alternativamente

PT Aperte alternadamente

S Dra åt växelvis

FIN Kierrä vuorotellen

EST Pinguldage vaheldumisi

LAT Pielieciet pamišus

LIT Užsukinėkite pakaitomis

PL Śruby dokręcaj naprzemiennie

RU Затягивайте попеременно

CZ Pokręťta багаžníka dokręcaj dokręcaj naprzemiennie.

SK Doťahujte striedavo

SLO Privijajte izmenično.

HR Naizmjenično zategnite

HU Egymástól függetlenül szorítandó

GR Σφιγγετε εναλλάξ

TR Dönüşümlü sıkın

中文 交替拧紧

한국어 번갈아 가며 조이십시오.

日本語 交互に締め付けてください。

ไทย ชันโนแบบสลับ

6



480R/754



480

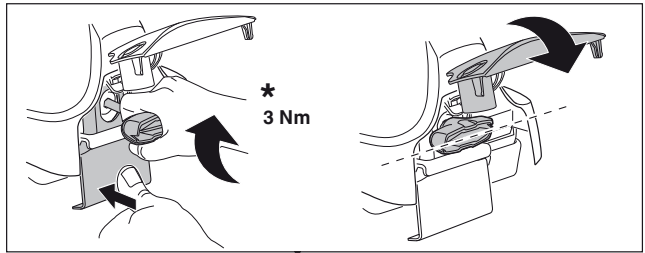
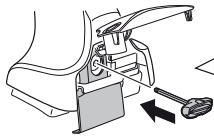

*
3 Nm



*

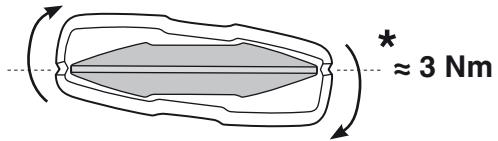

*
≈ 3 Nm

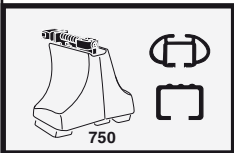
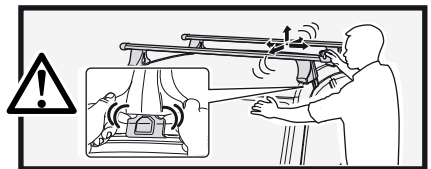

750

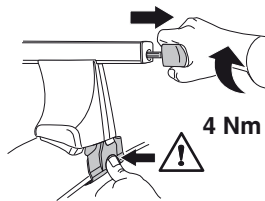

4 Nm

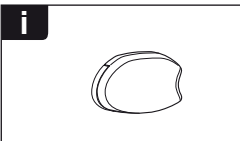
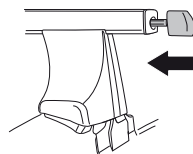

i

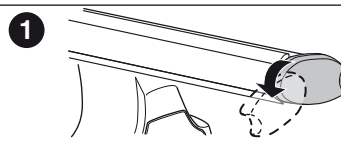

1

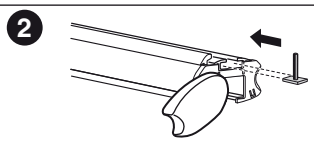

2

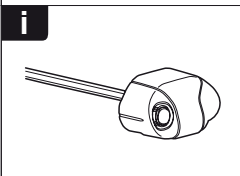

i

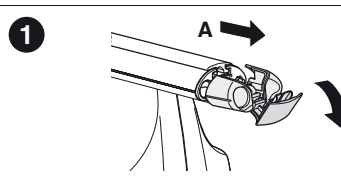

1

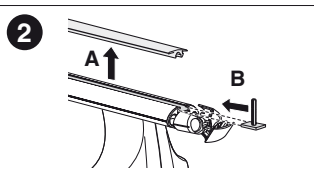

2

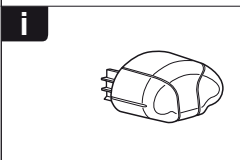

i

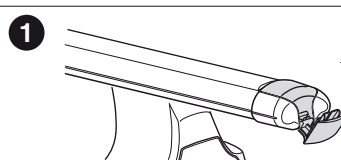

1

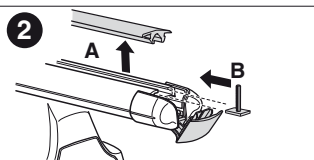

2



THULE
SWEDEN
**ONE
KEY
SYSTEM**



- 544 (x4)
- 596 (x6)
- 588 (x8)
- NA 510 (x10)
- EUR 452 (x12)
- ASIA



WW ▶ Thule Sweden AB, Box 69, 330 33 Hillerstorp, SWEDEN
NA ▶ Thule Inc., 42 Silvermine Road, Seymour, Connecticut 06483, USA

info@thule.com
customer.service@thule.com

www.thule.com